

**SG
SERIES**

**FEATURES: RADIAL TYPE HIGH TEMPERATURE CATEGORY +105°C
LONG LIFE CATEGORY CAPACITORS. FOR USE IN SMPS,
AUTOMOBILE ELECTRONIC CIRCUITS, INDUSTRIAL
EQUIPMENTS, LIGHTING SYSTEM etc.**

**ENDURANCE: +105°C, 5000 Hrs FOR DIAMETER > 6.3mm
+105 °C, 4000 Hrs FOR DIAMETER = 6.3mm
+105 °C, 3000 Hrs FOR DIAMETER = 5.0mm**

**REFERENCE
STANDARDS: IS4317/ IEC 384-4.**

**PRODUCT MARKING } PROVIDED WITH ORANGE COLOUR
SLEEVE AND BLACK PRINT**

PARAMETERS.	PERFORMANCE CHARACTERISTICS																																																																																										
Operating Temperature	- 40° C to +105 °C for WV ≤250 Vdc, -25°C to + 105°C for WV > 250 Vdc to 450 Vdc.																																																																																										
Working Voltage	16 to 100 Vdc and 250 to 450 Vdc.																																																																																										
Capacitance Range	1 to 4700µF (at +27° C, 100 Hz)																																																																																										
Capacitance Tolerance	±20%, (Other tolerance on request)																																																																																										
Leakage Current (After 3mt charging through 1000 Ω resistor) IL in µA	IL ≤ 0.01 CV or 4 µA, whichever is greater for WV 10 to 100 V ≤ 0.02 CV+ 10µA for WV 250 to 450 V, Where IL = Leakage current in µA C= Capacitance(µF) , V= Working Voltage in Volt																																																																																										
Dissipation factor (Tan δ) Max (at + 27°C, 100 Hz)	WV Vdc	16	25	35	40	50	63	100	250	350	400	450																																																																															
	Tan δ %	20	16	14	13	12	11	10	15	15	15	15																																																																															
	For Capacitor ratings with cap value >1000µF add 2% for every 1000µF increase																																																																																										
Low Temperature Stability	Impedance Ratio at 100 Hz.																																																																																										
	Rated Voltage (V)	16	25	35	40-50	63-100	250	350	400	450																																																																																	
	Z -25°C/Z + 27°C	3	3	2	2	2	3	7	7	7																																																																																	
	Z -40°C/ Z + 27°C	6	5	4	3	3	4	-	-	-																																																																																	
	Add 0.5 to the Ratio for Z- 25°C, 1.0 to the Ratio Z- 40°C Per 1000µF, for Cap>1000µF																																																																																										
Life Tests	<table border="1"> <thead> <tr> <th>Tests</th> <th colspan="6">Endurance DC Life Test</th> <th colspan="6">Storage Shelf Life Test</th> </tr> </thead> <tbody> <tr> <td>Test Condition</td> <td colspan="6">Capacitor at rated voltage and temperature (+105°C) [5000 Hrs for diameter > 6.3mm, 4000 Hrs for diameter = 6.3mm and 3000 Hrs for diameter = 5.0mm] Measurements after recovery to +27°C</td> <td colspan="6">Capacitor under no voltage At +105°C for 1000 Hrs Measurements after recovery to +27°C</td> </tr> <tr> <td>Parameters</td> <td colspan="6"></td> <td colspan="6"></td> </tr> <tr> <td>Δ Capacitance</td> <td colspan="6">Within±30% for 16 to 100 V Within ± 20% for 250 to 450V } of initial measured Value</td> <td colspan="6">Within±25% of initial measured value for 16 to 100 V Within±20% of initial measured value for 250 to 450 V</td> </tr> <tr> <td>Tan δ</td> <td colspan="6">Within 300% of initial limits for WV 16 ~100 V Within 200% of initial limits for WV 250 ~ 450 V</td> <td colspan="6">Within 150% of initial limits.</td> </tr> <tr> <td>D.C Leakage Current</td> <td colspan="6">Within initial limit</td> <td colspan="6">Within 150% of initial limit for 16 to 100 Vdc Within 200% of initial limit for 250 to 450 Vdc</td> </tr> </tbody> </table>													Tests	Endurance DC Life Test						Storage Shelf Life Test						Test Condition	Capacitor at rated voltage and temperature (+105°C) [5000 Hrs for diameter > 6.3mm, 4000 Hrs for diameter = 6.3mm and 3000 Hrs for diameter = 5.0mm] Measurements after recovery to +27°C						Capacitor under no voltage At +105°C for 1000 Hrs Measurements after recovery to +27°C						Parameters													Δ Capacitance	Within±30% for 16 to 100 V Within ± 20% for 250 to 450V } of initial measured Value						Within±25% of initial measured value for 16 to 100 V Within±20% of initial measured value for 250 to 450 V						Tan δ	Within 300% of initial limits for WV 16 ~100 V Within 200% of initial limits for WV 250 ~ 450 V						Within 150% of initial limits.						D.C Leakage Current	Within initial limit						Within 150% of initial limit for 16 to 100 Vdc Within 200% of initial limit for 250 to 450 Vdc					
	Tests	Endurance DC Life Test						Storage Shelf Life Test																																																																																			
	Test Condition	Capacitor at rated voltage and temperature (+105°C) [5000 Hrs for diameter > 6.3mm, 4000 Hrs for diameter = 6.3mm and 3000 Hrs for diameter = 5.0mm] Measurements after recovery to +27°C						Capacitor under no voltage At +105°C for 1000 Hrs Measurements after recovery to +27°C																																																																																			
	Parameters																																																																																										
	Δ Capacitance	Within±30% for 16 to 100 V Within ± 20% for 250 to 450V } of initial measured Value						Within±25% of initial measured value for 16 to 100 V Within±20% of initial measured value for 250 to 450 V																																																																																			
Tan δ	Within 300% of initial limits for WV 16 ~100 V Within 200% of initial limits for WV 250 ~ 450 V						Within 150% of initial limits.																																																																																				
D.C Leakage Current	Within initial limit						Within 150% of initial limit for 16 to 100 Vdc Within 200% of initial limit for 250 to 450 Vdc																																																																																				
(i). Endurance Test at High Temperature +105°C at WV.																																																																																											
(ii). Storage Test at High Temperature +105°C at 0V.																																																																																											

OTHER INFORMATION

Type of Packing	Bulk Packing - Straight Lead For details refer to page no. 7
Capacitor Codification System	For details refer to page no. 4
Dimensional Specification	For details refer to page no. 5
Marking Specification	For details refer to page no. 6

As part of continuous development Design and specifications are subject to change without notice.

SGSERIES

STANDARD RATING TABLE (For WV <250 Vdc): -

Provides detailed information regarding applicable case size and the appropriate ripple current handling capability of the defined case size.

WV SV Cap(µF)	16		25		35		40		50		63		80		100	
	CC	RC	CC	RC	CC	RC	CC	RC	CC	RC	CC	RC	CC	RC		
1.0											HS	17			HS	16
2.2									HS	22	HS	22	HS	22	AS	23
3.3									HS	27	AS	26	AS	26	BB	41
4.7									HS	33	AS	38	AS	36	BB	45
6.8									HS	41	AS	48	AS	46	BB	50
10					HS	59	HS	52	HS	47	AS	69	AS	64	CB	82
22			HS	62	HS	71	HS	69	AS	83	AS	82	BB	94	CB	131
33			HS	75	HS	81	HS	78	AS	100	BB	130	BB	124	CB	160
47	HS	82	HS	90	AS	110	AS	110	BB	166	BB	160	CB	174	CD	204
68	HS	98	AS	133	AS	130	AS	128	BB	190	CB	233	CB	220	CG	262
100	AS	146	AS	174	BB	254	BB	239	CB	290	CB CD	276 310	CD	295	CG	302
220	BB	280	BB	278	CB	390	CB	356	CG	480	CG	450	DG	486	DK	524
330	BB	350	CB	400	CD	505	CD	480	CG	584	DG	620	DK	680	EK	802
470	CB	470	CD	520	CG	640	CG	610	DG	838	DK	860	EK	912	ER	1029
680	CD	579	CG	640	CK	720	CK DG	710 830	DK	920	EK	1104	ER	1192	SH	1452
1000	CD	650	CG DG	770 850	DG	840	DK	1050	EK	1306	ER	1420	SH	1512	TH	1960
1200	CG	778	CK	1011	DK	1144	DK EK	1100 1200	ER	1452	EU	1545	SJ	1806	TM	2162
1500	CG	795	DG	1109	EK	1312	EK	1300	EU	1617	SH	1720	TH	2150	TM	2380
2200	DG	1065	DK	1214	EK	1450	ER	1615	SH	1910	TH	2151	TM	2618		
3300	DK	1280	EK	1580	EU	1900	SH	2080	TJ	2395	TM	2603				
4700	EK	1650	EU	2100	SH	2280	TH	2598	TM	2961						

Abbreviations used:

WV : Working voltage of the capacitor in Volts.

SV : Surge voltage in volts.

Cap : Capacitance in microfarad.

CC : Case code.

RC : Maximum Ripple current allowed in milli ampere at 100 Hz/ +105°C

Frequency Multiplier For Ripple Current
(For WV < 250 Vdc)

Temperature Multiplier For Ripple Current
(For WV <250 Vdc)

WV Vdc	Freq(Hz) Cap (µF)	50	100	120	300	1K	10K and above
		<68	0.81	1	1.07	1.44	1.68
100 ~ 680		0.85	1	1.06	1.30	1.42	1.59
1000 ~ 4700		0.89	1	1.05	1.15	1.18	1.20

Temp (°C)	40	60	70	85	95	105
Multipliers	1.85	1.75	1.61	1.4	1.25	1

As part of continuous development Design and specifications are subject to change without notice.

SG SERIES

STANDARD RATING TABLE (For WV ≥250 Vdc) :-

Provides detailed information regarding applicable case size and the appropriate ripple current handling capability of the defined case size.

WV SV Cap(µF)	250		350		400		450	
	285		385		440		500	
	CC	RC	CC	RC	CC	RC	CC	RC
1.8							CD	34
2.2					CD	36	CD	36
3.3					CD CG	40 46	CD CG	40 46
4.7	CD	52	CD	48	CD CG	46 52	CG	52
5.6	CD	60	CD	54	CG DG	60 68	CG DG	60 60
6.8	CD	76	CD CG	68 88	CG DG	72 88	CG DG	72 80
10	CD CG	112 128	CG	112	DG DK	128 144	DG DK	128 144
22	DG	240	DK	140 160	DK EK	160 220	EK	220
33	EK	280	EK	240	EK EU	240 288	ER	280
47	EK	320	ER	280	EU	336	SH	360
68	EK	360	EU	380	SH	470	SJ	490
100	ER	465	SH	520	TH	600	TH TJ	620 688
220	TH	840	TM	920				
330	TM	1060						

Abbreviations used:

WV : Working voltage of the capacitor in Volts.

SV : Surge voltage in volts.

Cap : Capacitance in microfarad.

CC : Case code.

RC : Maximum Ripple current allowed in milli ampere at 100 Hz/ +105°C

Frequency Multiplier for Ripple Current
(For WV > 250 Vdc)

Temperature Multiplier for Ripple Current
(For WV >250 Vdc)

WV Vdc	Freq(Hz) Cap (µF)	Freq(Hz)					
		50	100	120	300	1K	10K and above
250 ~ 450	1~10	0.80	1	1.10	1.60	2.10	2.50
	22 ~ 47	0.85	1	1.06	1.40	1.70	2.00
	68 ~ 330	0.90	1	1.05	1.31	1.48	1.70

Temp (°C)	40	60	70	85	95	105
Multipliers	1.85	1.75	1.61	1.4	1.25	1

SG SERIES

1. CAPACITOR ORDERING INFORMATION:

Capacitors are identified with the help of 12-digit code. Expansion of Part Nos. for SA, SE, SH, SN, SZ, SB, SD, SX, SG and SL series capacitors are detailed below.

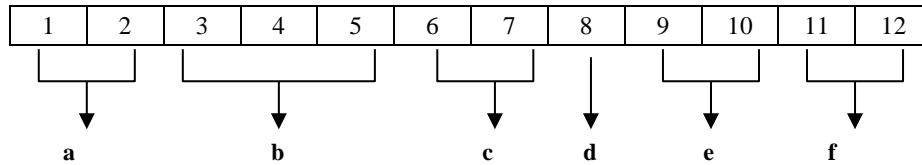

a																			
Series Code. Eg: SA, SE, SH, SN, SZ, SB, SX, SD, SG and SL																			
b																			
Capacitance Value Code																			
Capacitance (µF)	0.1	1	0.22	2.2	22	220	2200	22000											
Code	R10	010	R22	2R2	220	221	222	223											
c																			
Voltage Code																			
Working Voltage (V)	6.3	10	12	16	25	35	40	50	63	100	160	200	250	315	350	400	420	450	500
Code	0J	1A	1B	1C	1E	1V	1G	1H	1J	2A	2C	2D	2E	2P	2V	2G	2U	2W	2H
d																			
Tolerance Code																			
Tolerance	Capacitance Tolerance														Speci. Cap Tolerance	Speci. Tanδ Tolerance			
	±5%	± 10%		± 20%		± 30%		-10% +30%		-10% +50%				A	S				
Code	J	K		M		N		Q		T									
e						f													
Size Code						Capacitor Lead wire Termination Code													
Follow respective Dimensional specification. Eg: HS, AS, BB etc.						Provided by the factory based on customer requirements. Eg:													
						Item	Taped 5mm pitch	Taped 2.5mm pitch	Formed & cut	Kinking & cut	Bulk packing straight lead								
						Code	T0	T2	F0	FD	B0								

Capacitor Codification System :-

Example (i) 0.47µf / 63V; SE Series
Bulk Packing - Straight Lead

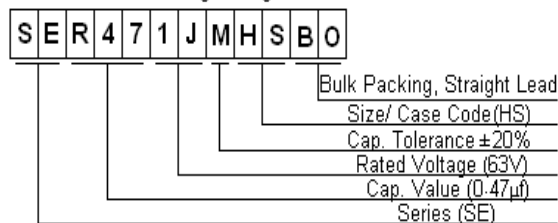

Example (ii) 2200µf / 35V; SA Series
Kinking & Cut

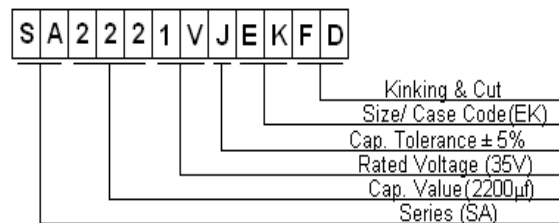

Example (iii) 47µf / 25V; SE Series
Taped 5mm Pitch - Ammo pack

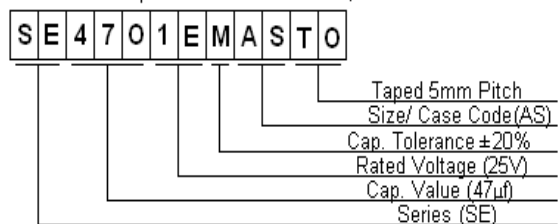

Example (iv) 470µf / 25V; SA Series
Bulk Packing - Straight Lead

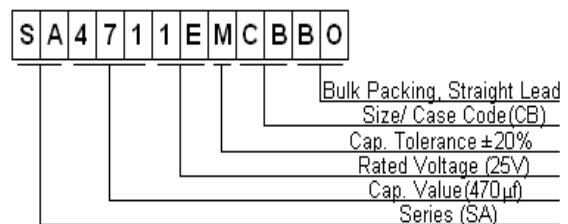

As part of continuous development Design and specifications are subject to change without notice.

SGSERIES

2. DIMENSIONAL SPECIFICATION

Dimensions of SG series capacitors are detailed below.

Case Code	Diameter $\varnothing D \pm 0.5$ (mm)	Length $L \pm 1.0$ (mm)	Pitch $P \pm 0.5$ (mm)	Lead Dia $\varnothing d \pm 0.05$ (mm)
HS	5	11	2	0.5
AS	6.3	11	2.5	0.5
BB	8	12.5	3.5	0.6
CB	10	12.5	5	0.6
CD	10	16	5	0.6
CG	10	21	5	0.6
CK	10	25	5	0.6
DG	12.5	21	5	0.6
DK	12.5	25	5	0.6
EK	16	25	7.5	0.8
ER	16	31	7.5	0.8
EU	16	36	7.5	0.8
SR	18	31	7.5	0.8
SH	18	37	7.5	0.8
SJ	18	41	7.5	0.8
TH	22	37	10	0.8
TJ	22	41	10	0.8
TM	22	52	10	0.8

(All Dimensions in mm)

PHYSICAL OUTLINE

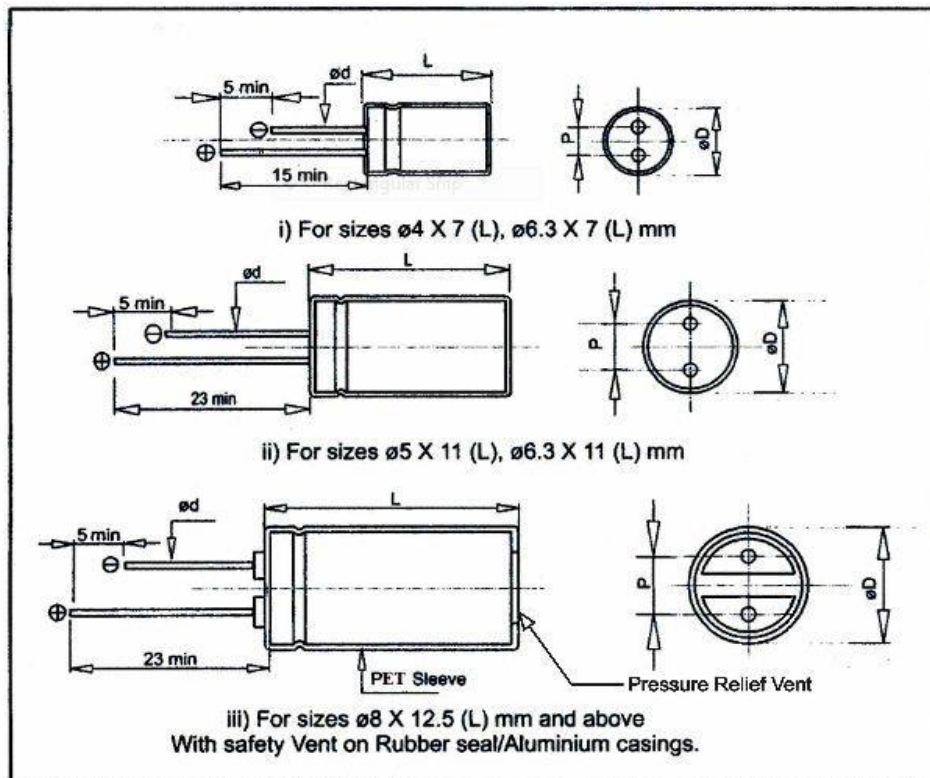

As part of continuous development Design and specifications are subject to change without notice.

SG SERIES

3. MARKING ON THE CAPACITOR

Marking specifications of SA, SE, SN, SH, SZ, SD, SB, SX, SG and SL series capacitors are detailed below. Below mentioned details are printed on orange coloured vinyl sleeve with black print.

- a) Manufacturer’s name and logo

- b) Capacitor series & upper category temperature
- c) Nominal capacitance value in μF
- d) Capacitance tolerance code
- e) Rated working voltage in V
- f) Date code (Year-Month)
- g) Negative terminals are indicated on the sleeve

Note: Manufacturer’s logo, capacitor series, upper category temperature and date code are marked only for sizes \varnothing 8mm and above.

Date Code:

Date code is provided on the capacitor sleeve in Year – Month format for sizes \varnothing 8mm and above. Year & Month code of SA, SE, SN, SH, SZ, SD, SG & SL capacitor of diameter \varnothing 8mm & above are detailed below.

Year code

Year	2000	2001	2002	2003	2004	2005	2006	2007	2008	2009
Letter Code	M	N	P	R	S	T	U	V	W	X

Year	2010	2011	2012	2013	2014	2015	2016	2017	2018	2019
Letter Code	A	B	C	D	E	F	H	J	K	L

Year codes repeats after each cycle of 20 years.

Month Code

Month	Jan.	Feb.	Mar.	Apr.	May	June	July	Aug	Sep.	Oct.	Nov	Dec.
Code	1	2	3	4	5	6	7	8	9	O	N	D

SG SERIES

PRIMARY PACKING STANDARD BULK PACKING

SA, SE, SN, SH, SZ, SD, SB, SX, SG and SL series capacitors are generally BULK PACKED in thick polythene bags which are heat sealed to avoid direct atmospheric exposure. Individual primary packing in polythene bag is provided with a LABEL which carries outgoing Inspection Report No, Work Order No, Capacitor Series, Capacitance Value, Working Voltage, Capacitor tolerance, Capacitor size, Capacitor Part No, Temperature, Quantity and Date of packing. **IT IS CUSTOMARY TO RETURN THE PACKING LABEL TO THE FACTORY IN CASE OF QUANTITY/QUALITY NON-CONFORMANCE.**

BULK PACKING QUANTITY DETAILS

Size (Ø D x Lmm)	4x7	6.3x7	5x11	6.3x11	8x12.5	10x12.5	10x16	10x20	10x25	12.5x21
Case code	47	67	HS	AS	BB	CB	CD	CG	CK	DG
Nos/ Bag	500	500	500	500	500	300	300	300	200	200
Nos/ Carton	5000	5000	5000	4000	2500	1800	1500	1200	1000	800
Wt. (Kg) 1000 Nos (Approx)	1.2	2.1	2.2	2.6	2.6	3.3	3.0	2.9	3.3	3.2

Size (Ø D x Lmm)	12.5x25	16x25	16x31	16x36	18x31	18x37	18x41	22x37	22x41	22x52
Case code	DK	EK	ER	EU	SR	SH	SJ	TH	TJ	TM
Nos/ Bag	200	100	100	100	50	50	50	50	25	25
Nos/ Carton	600	400	300	300	200	200	200	150	125	75
Wt. (Kg) 1000 Nos (Approx)	2.8	2.7	2.9	3.3	2.4	2.8	3.2	3.1	2.8	2.2

As part of continuous development Design and specifications are subject to change without notice.